

profiglass.lt

 **PROFI
GLASS**
●▲ FITTINGS

05

„U“ PROFILIAI,
SLENKŠČIAI IR TARPINĖS
“U” PROFILES,
DOORSTEPS AND SEALS

“U” profilis | PRO-800

„U” profile



Produkto kodas Product code	L	Padengimas Finish
PRO-800-2,5-CH	2500	chromuotas / chrome
PRO-800-2,5-SS	2500	satinas / satin
PRO-800-2,5-B	2500	juodas / black
PRO-800-2,5-G	2500	auksas / gold
PRO-800-2,5-NA	2500	anoduotas / anodised
PRO-800-3,0-CH	3000	chromuotas / chrome
PRO-800-3,0-SS	3000	satinas / satin
PRO-800-3,0-B	3000	juodas / black
PRO-800-3,0-G	3000	auksas / gold

Savybės | Properties

Stiklo storis / Glass thickness 8 mm

Medžiaga / Material aliuminis / aluminium

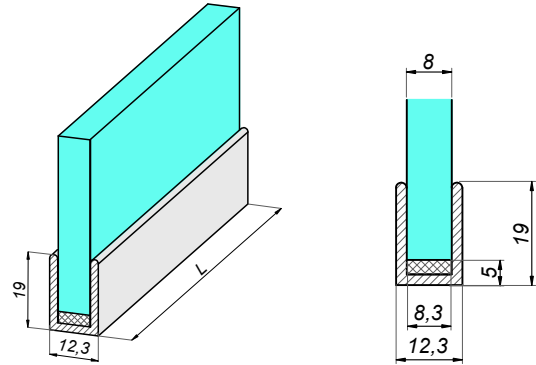

“U” profilis | PRO-810

„U” profile



Produkto kodas Product code	L	Padengimas Finish
PRO-810-2,5-CH	2500	chromuotas / chrome
PRO-810-2,5-SS	2500	satinas / satin
PRO-810-2,5-B	2500	juodas / black
PRO-810-3,0-CH	3000	chromuotas / chrome
PRO-810-3,0-SS	3000	satinas / satin
PRO-810-3,0-B	3000	juodas / black

Savybės | Properties

Stiklo storis / Glass thickness 10 mm

Medžiaga / Material aliuminis / aluminium

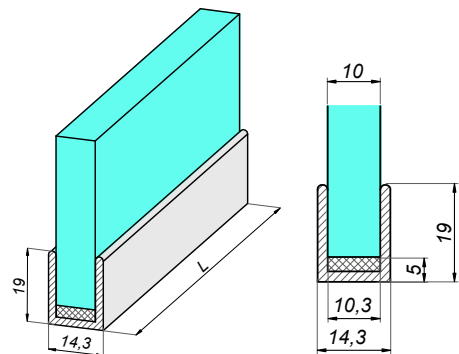

“U” profilio dangtelis | PRO-800-Z

Endcap for „U” profile

Produkto kodas Product code	Padengimas Finish
PRO-800-Z-CH	chromuotas / chrome
PRO-800-Z-SS	satinas / satin
PRO-800-Z-B	juodas / black

Savybės | Properties

Medžiaga / Material plienas / stainless steel

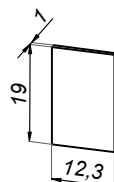

“U” profilio dangtelis | PRO-810-Z

Endcap for „U” profile

Produkto kodas Product code	Padengimas Finish
PRO-810-Z-CH	chromuotas / chrome
PRO-810-Z-SS	satinas / satin
PRO-810-Z-B	juodas / black

Savybės | Properties

Medžiaga / Material plienas / stainless steel

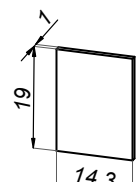

„U“ profilis | PRO-3000

„U“ profile



Produkto kodas Product code	L	Padengimas Finish
PRO-3000-2,5-CH	2500	chromuotas / chrome
PRO-3000-2,5-SS	2500	satinas / satin
PRO-3000-2,5-B	2500	juodas / black
PRO-3000-2,5-NA	2500	anoduotas / anodised
PRO-3000-3,0-CH	3000	chromuotas / chrome
PRO-3000-3,0-SS	3000	satinas / satin
PRO-3000-3,0-B	3000	juodas / black
PRO-3000-3,0-NA	3000	anoduotas / anodised

Savybės | Properties

Stiklo storis / Glass thickness 8-12 mm

Medžiaga / Material aliuminis / aluminium

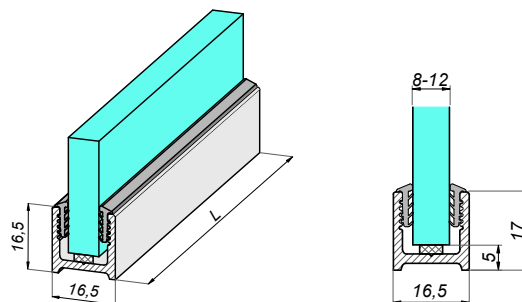

Aukštas „U“ profilis | PRO-3500

High „U“ profile



Produkto kodas Product code	L	Padengimas Finish
PRO-3500-2,5-CH	2500	chromuotas / chrome
PRO-3500-2,5-SS	2500	satinas / satin
PRO-3500-2,5-B	2500	juodas / black

Savybės | Properties

Stiklo storis / Glass thickness 8-12 mm

Medžiaga / Material aliuminis / aluminium

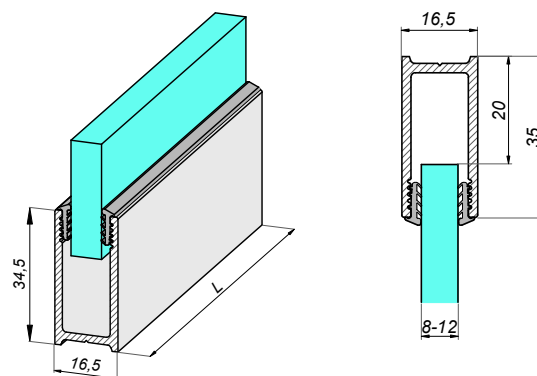

„U“ profilio dangtelis | PRO-3500-Z

Endcap for „U“ profile

Produkto kodas Product code	Padengimas Finish
PRO-3500-Z-CH	chromuotas / chrome
PRO-3500-Z-SS	satinas / satin
PRO-3500-Z-B	juodas / black

Savybės | Properties

Medžiaga / Material plienas / stainless steel

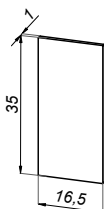

„U“ profilio dangtelis | PRO-3000-Z

Endcap for „U“ profile

Produkto kodas Product code	Padengimas Finish
PRO-3000-Z-CH	chromuotas / chrome
PRO-3000-Z-SS	satinas / satin
PRO-3000-Z-B	juodas / black

Savybės | Properties

Medžiaga / Material plienas / stainless steel

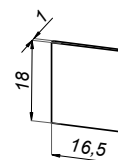

“U” profilio tarpinė | PRO-G-3000

„U” profile seal

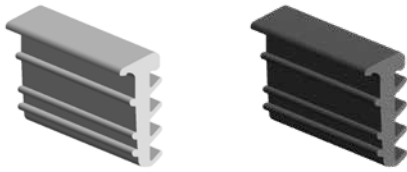

Produkto kodas Product code	Padengimas Finish
PRO-G-3000	○ bespalvis / colorless
PRO-G-3000-B	● juodas / black
Savybės Properties	
Medžiaga / Material	PVC

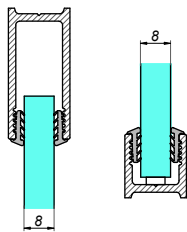
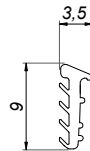

Stiklas 8 mm

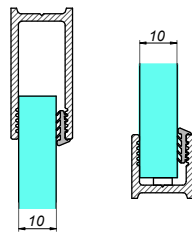

Stiklas 10 mm

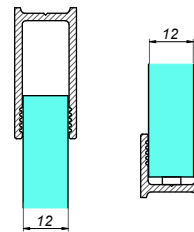

Stiklas 12 mm

“U” profilio tarpinė | PRO-G-3500

„U” profile seal

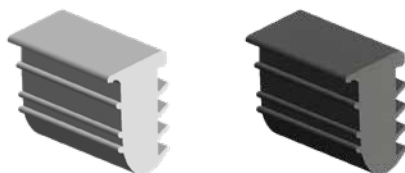

Produkto kodas Product code	Padengimas Finish
PRO-G-3500	○ bespalvis / colorless
PRO-G-3500-B	● juodas / black
Savybės Properties	
Medžiaga / Material	PVC

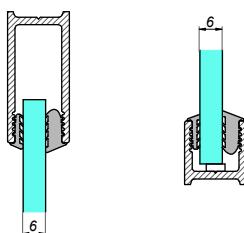
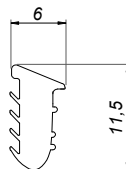

Stiklas 6 mm

Apdailos juosta | CS-1902

Grid profile



Produkto kodas Product code	L	Padengimas Finish
--------------------------------	---	----------------------

CS-1902-3000-CH	3000	● chromuotas / chrome
-----------------	------	-----------------------

CS-1902-3000-B	3000	● juodas / black
----------------	------	------------------

CS-1902-3000-G	3000	● auksas / gold
----------------	------	-----------------

Savybės | Properties

Dydis / Size	19x2 mm
--------------	---------

Medžiaga / Material	aliuminis / aluminium
---------------------	-----------------------

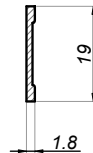

Dvipusė klijuojama juosta

Tape for grid profiles



Produkto kodas Product code	L	Padengimas Finish
--------------------------------	---	----------------------

CS-0,7-9-33	33m	● juodas / black
-------------	-----	------------------

Savybės | Properties

Dydis / Size	0,7x9 mm
--------------	----------

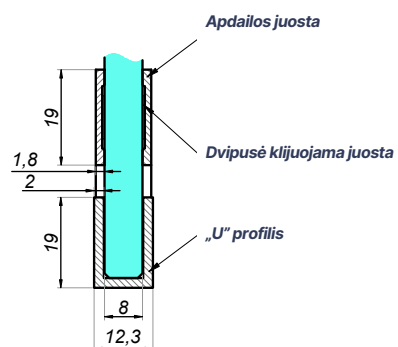
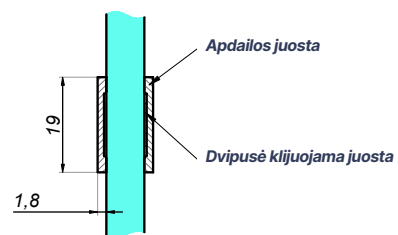

Slenkstis | SK-2968

Doorstep



Produkto kodas Product code	L	Padengimas Finish
SK-2968-6	2000	○ bespalvis / colorless
SK-2968-8	2000	○ bespalvis / colorless
SK-2968-10	2000	○ bespalvis / colorless
Savybės / Properties		
Medžiaga / Material akrilinis stiklas / acrylic glass		

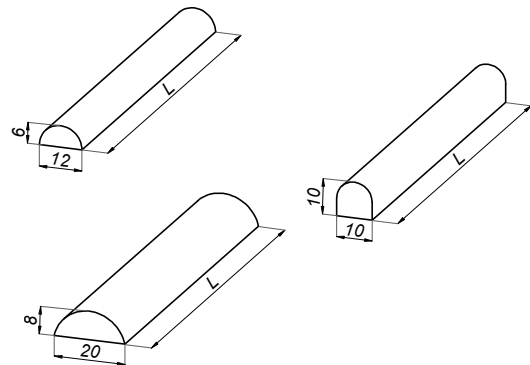

Slenkstis | SL

Doorstep



Produkto kodas Product code	L	Padengimas Finish
SL1-CH	1000	● chromuotas / chrome
SL1-B	1000	● juodas / black
SL1-G	1000	● auksas / gold
SL2-CH	2000	● chromuotas / chrome
SL2-B	2000	● juodas / black
SL2-G	2000	● auksas / gold
Savybės / Properties		
Medžiaga / Material aliuminis / aluminium		

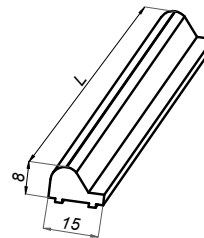

Jungtis 90° slenkstis-slenkstis | NT90

Connector 90° doorstep-doorstep



Produkto kodas Product code	Padengimas Finish
NT90-CH	● chromuotas / chrome
NT90-B	● juodas / black
NT90-G	● auksas / gold
Savybės / Properties	
Medžiaga / Material ABS	

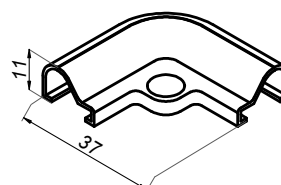

Jungtis 90° slenkstis-stiklas | NT90

Connector 90° doorstep-glass



Produkto kodas Product code	Padengimas Finish
NT90L-CH	● chromuotas / chrome
NT90L-B	● juodas / black
NT90L-G	● auksas / gold
NT90R-CH	● chromuotas / chrome
NT90R-B	● juodas / black
NT90R-G	● auksas / gold
Savybės / Properties	
Stiklo storis / Glass thickness	8 mm
Medžiaga / Material	ABS

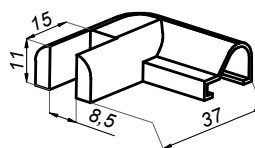
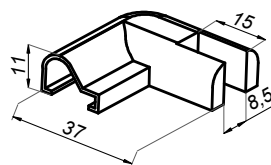

Jungtis 135° slenkstis-stiklas | NT135

Connector 135° doorstep-glass



Produkto kodas Product code	Padengimas Finish
NT135L-CH	● chromuotas / chrome
NT135R-CH	● chromuotas / chrome
Savybės / Properties	
Stiklo storis / Glass thickness	8 mm
Medžiaga / Material	ABS

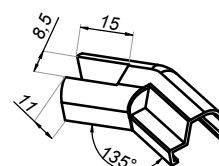
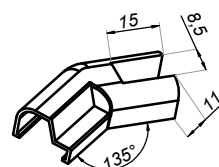

Jungtis 180° slenkstis-stiklas | NT180

Connector 180° doorstep-glass



Produkto kodas Product code	Padengimas Finish
---------------------------------------	-----------------------------

NT180R-CH	● chromuotas / chrome
------------------	-----------------------

NT180R-B	● juodas / black
-----------------	------------------

NT180R-G	● auksas / gold
-----------------	-----------------

NT180L-CH	● chromuotas / chrome
------------------	-----------------------

NT180L-B	● juodas / black
-----------------	------------------

NT180L-G	● auksas / gold
-----------------	-----------------

Savybės | Properties

Stiklo storis / Glass thickness	8 mm
--	------

Medžiaga / Material	ABS
----------------------------	-----

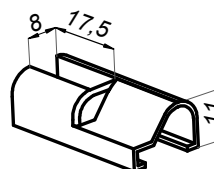
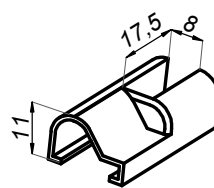

“H” tarpinė su ūseliu | TAR-2900

„H” seal

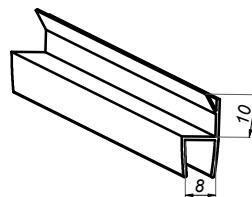

Produkto kodas Product code	Stiklo storis Glass thickness	Padengimas Finish
TAR-2900-6-2,5	6 mm	○ bespalvis / colorless
TAR-2900-8-2,5	8 mm	○ bespalvis / colorless
TAR-2900-8-2,5-B	8 mm	● juodas / black
Savybės Properties		
Medžiaga / Material		PVC
Ilgis / Length		2500 mm

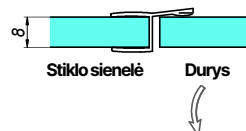
**“H” tarpinė su ūseliu | TAR-2901**

„H” seal

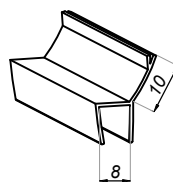

Produkto kodas Product code	Stiklo storis Glass thickness	Padengimas Finish
TAR-2901-8-2,5	8 mm	○ bespalvis / colorless
Savybės Properties		
Medžiaga / Material		PVC
Ilgis / Length		2500 mm

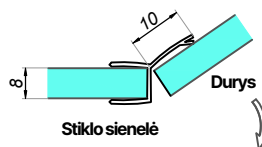
**“F” tarpinė 15mm | TAR-2902S**

„F” seal

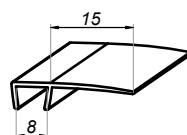

Produkto kodas Product code	Stiklo storis Glass thickness	Padengimas Finish
TAR-2902S-6-2,5	6 mm	○ bespalvis / colorless
TAR-2902S-8-2,5	8 mm	○ bespalvis / colorless
TAR-2902S-8-2,5-B	8 mm	● juodas / black
Savybės Properties		
Medžiaga / Material		PVC
Ilgis / Length		2500 mm

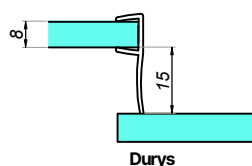

“F” tarpinė 24mm | TAR-2902

„F” seal

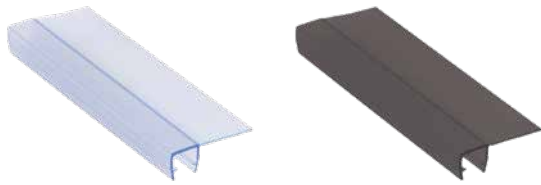

Produkto kodas Product code	Stiklo storis Glass thickness	Padengimas Finish
TAR-2902-8-2,5	8 mm	○ bespalvis / colorless
TAR-2902-8-2,5-B	8 mm	● juodas / black
Savybės Properties		
Medžiaga / Material		PVC
Ilgis / Length		2500 mm

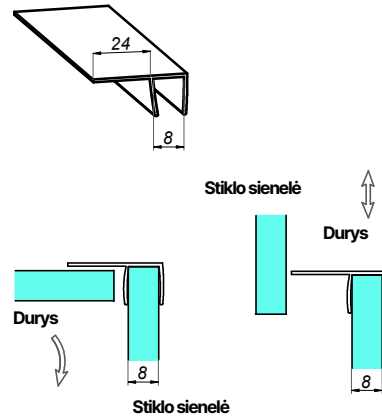

Apatinė tarpinė 16mm | TAR-2903

Bottom seal 16mm



Produkto kodas Product code	Stiklo storis Glass thickness	Padengimas Finish
TAR-2903-6-2,5	8 mm	○ bespalvis / colorless
Savybės Properties		
Medžiaga / Material		PVC
Ilgis / Length		2500 mm

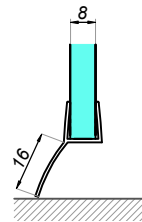
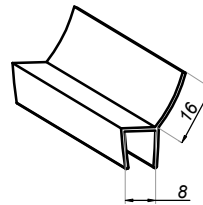

“H” tarpinė 18mm | TAR-2905

„H” seal 18mm

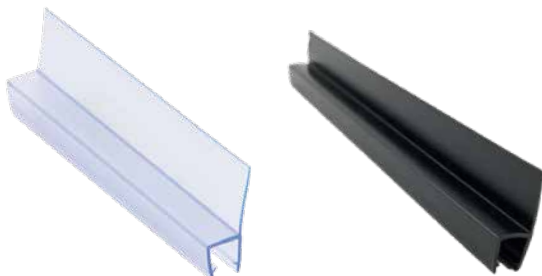

Produkto kodas Product code	Stiklo storis Glass thickness	Padengimas Finish
TAR-2905-6-2,5	6 mm	○ bespalvis / colorless
TAR-2905-8-2,5	8 mm	○ bespalvis / colorless
TAR-2905-8-2,5-B	8 mm	● juodas / black
Savybės Properties		
Medžiaga / Material		PVC
Ilgis / Length		2500 mm

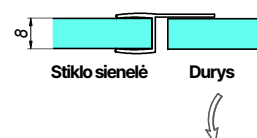
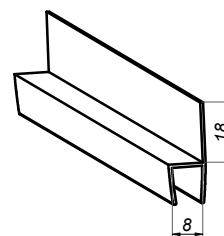

“H” tarpinė | TAR-2905S

„H” seal

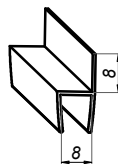
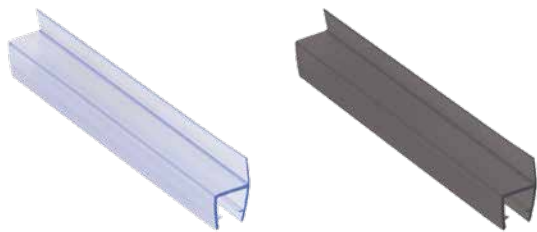

Produkto kodas Product code	Stiklo storis Glass thickness	Padengimas Finish
TAR-2905S-6-2,5	6 mm	○ bespalvis / colorless
TAR-2905S-8-2,5	8 mm	○ bespalvis / colorless
TAR-2905S-8-2,5-B	8 mm	● juodas / black
Savybės Properties		
Medžiaga / Material		PVC
Ilgis / Length		2500 mm

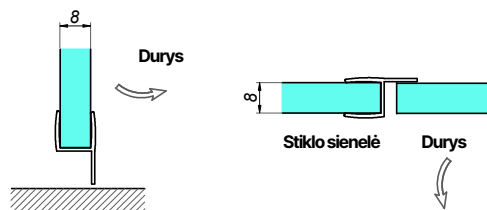
**Apatinė tarpinė su L | TAR-2906**

Bottom seal with L

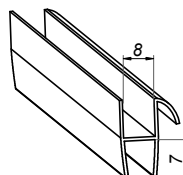
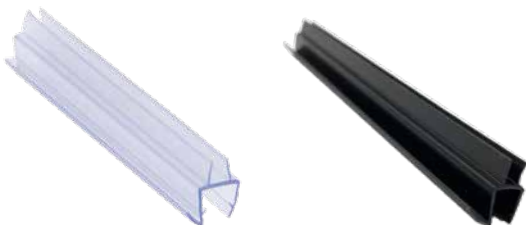

Produkto kodas Product code	Stiklo storis Glass thickness	Padengimas Finish
TAR-2906-6-2,5	6 mm	○ bespalvis / colorless
TAR-2906-8-2,5	8 mm	○ bespalvis / colorless
TAR-2906-8-2,5-B	8 mm	● juodas / black
Savybės Properties		
Medžiaga / Material		PVC
Ilgis / Length		2500 mm

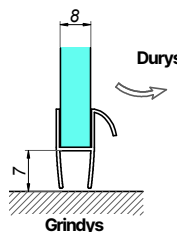
**Apatinė tarpinė | TAR-2913**

Bottom seal

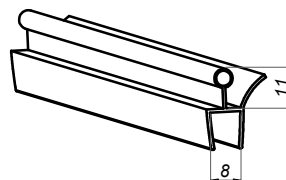

Produkto kodas Product code	Stiklo storis Glass thickness	Padengimas Finish
TAR-2913-6-2,5	6 mm	○ bespalvis / colorless
TAR-2913-8-2,5	8 mm	○ bespalvis / colorless
TAR-2913-8-2,5-B	8 mm	● juodas / black
Savybės Properties		
Medžiaga / Material		PVC
Ilgis / Length		2500 mm

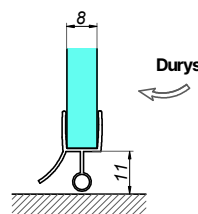

Apatinė tarpinė | TAR-2914

Bottom seal

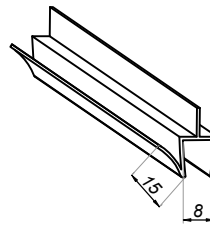

Produkto kodas Product code	Stiklo storis Glass thickness	Padengimas Finish
TAR-2914-8-2,5	8mm	○ bespalvis / colorless
Savybės Properties		
Medžiaga / Material		PVC
Ilgis / Length		2500 mm

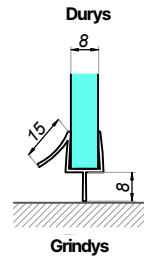

Apatinė tarpinė "D" | TAR-2910

Bottom seal „D“

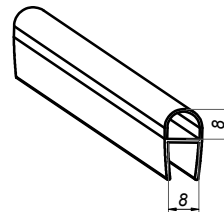

Produkto kodas Product code	Stiklo storis Glass thickness	Padengimas Finish
TAR-2910-6-2,5	6 mm	○ bespalvis / colorless
TAR-2910-8-2,5	8 mm	○ bespalvis / colorless
TAR-2910-8-2,5-B	8 mm	● juodas / black
Savybės Properties		
Medžiaga / Material		PVC
Ilgis / Length		2500 mm

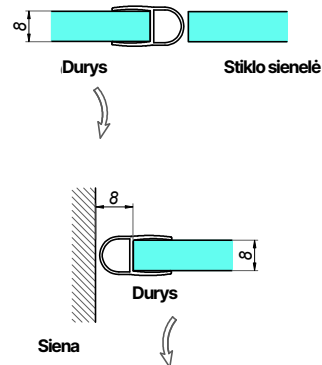

Tiesi magnetinė tarpinė 180° | TAR-2907

Straight magnetic seal 180°

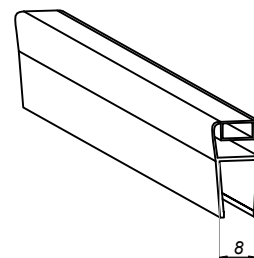
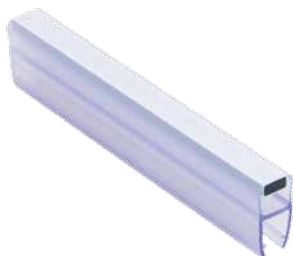

Produkto kodas Product code	Stiklo storis Glass thickness	Padengimas Finish
TAR-2907-6-2,5	6 mm	○ bespalvis / colorless
TAR-2907-8-2,5-B	8 mm	○ juodas / black
Savybės Properties		
Medžiaga / Material		PVC
Ilgis / Length		2500 mm

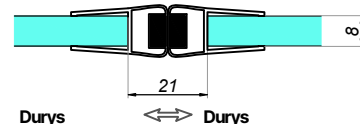

Magnetinė tarpinė 135° | TAR-2908

Magnetic seal 135°

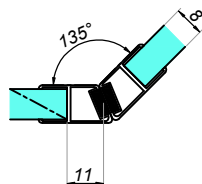
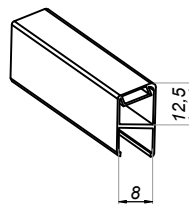

Produkto kodas Product code	Stiklo storis Glass thickness	Padengimas Finish
TAR-2908-6-2,5	6 mm	○ bespalvis / colorless
TAR-2908-8-2,5-B	8 mm	○ juodas / black
Savybės Properties		
Medžiaga / Material		PVC
Ilgis / Length		2500 mm

Magnetinė tarpinė 90° / 180° | TAR-2909

Magnetic seal 90° / 180°

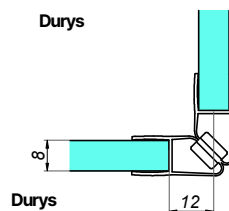
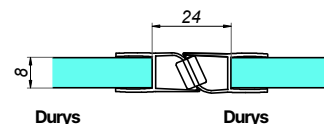
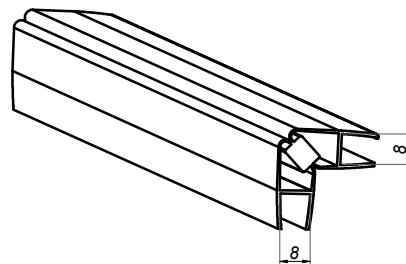

Produkto kodas Product code	Stiklo storis Glass thickness	Padengimas Finish
TAR-2909-6-2,5	6 mm	○ bespalvis / colorless
TAR-2909-8-2,5	8 mm	○ bespalvis / colorless
TAR-2909-8-2,5-B	8 mm	● juodas / black
Savybės Properties		
Medžiaga / Material		PVC
Ilgis / Length		2500 mm

Tarpinė stiklas-stiklas 90° | SC-90-10-3

Seal glass-glass 90°

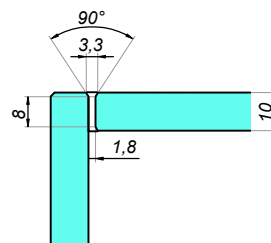
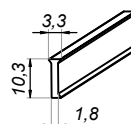

Produkto kodas Product code	Stiklo storis Glass thickness	Padengimas Finish
SC-90-10-3	10 mm	○ bespalvis / colorless
Savybės Properties		
Medžiaga / Material		akrilas / acrylic glass
Ilgis / Length		3000 mm

Tarpinė stiklas-stiklas 180° | SC-180-10-3

Seal glass-glass 180°

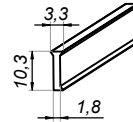

Produkto kodas Product code	Stiklo storis Glass thickness	Padengimas Finish
SC-180-10-3	10 mm	○ bespalvis / colorless
Savybės / Properties		
Medžiaga / Material	akrilas / acrylic glass	
Ilgis / Length	3000 mm	

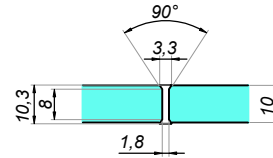

Klijuojama "D" formos tarpinė | SP-2915

Self adhesive seal

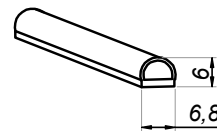

Produkto kodas Product code	Stiklo storis Glass thickness	Padengimas Finish
SP-2915	8 mm	○ bespalvis / colorless
Savybės / Properties		
Medžiaga / Material	PVC	
Ilgis / Length	2500 mm	

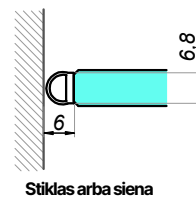

Stiklas arba siena

Klijuojama apatinė tarpinė | SP-2913T

Self adhesive seal

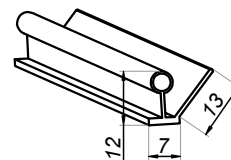

Produkto kodas Product code	Stiklo storis Glass thickness	Padengimas Finish
SP-2913T	8 mm	○ bespalvis / colorless
Savybės / Properties		
Medžiaga / Material	PVC	
Ilgis / Length	2500 mm	

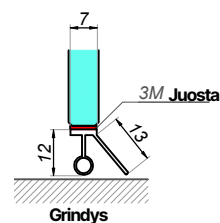

Grindys

Klijuojama magnetinė tarpinė 90° | SP-2909T-90

Self adhesive magnetic seal 90°

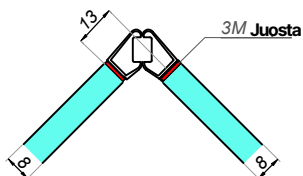
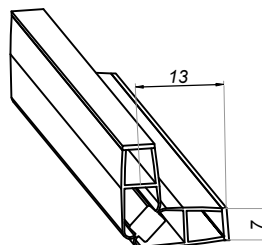

Produkto kodas Product code	Stiklo storis Glass thickness	Padengimas Finish
SP-2909T-90-8-2,5	8 mm	○ bespalvis / colorless
Savybės / Properties		
Medžiaga / Material		PVC
Ilgis / Length		2500 mm

**Klijuojama magnetinė tarpinė 180° | SP-2909T-180**

Self adhesive magnetic seal 180°



Produkto kodas Product code	Stiklo storis Glass thickness	Padengimas Finish
SP-2909T-180-8-2,5	8 mm	○ bespalvis / colorless
Savybės / Properties		
Medžiaga / Material		PVC
Ilgis / Length		2500 mm

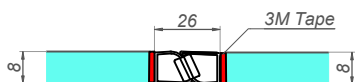
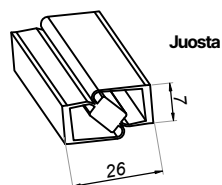

Aliuminio profilis su magnetine tarpine 90° siena-stiklas MAGNUM | MAG90-G-W

Aluminium magnetic seal 90° wall-glass MAGNUM

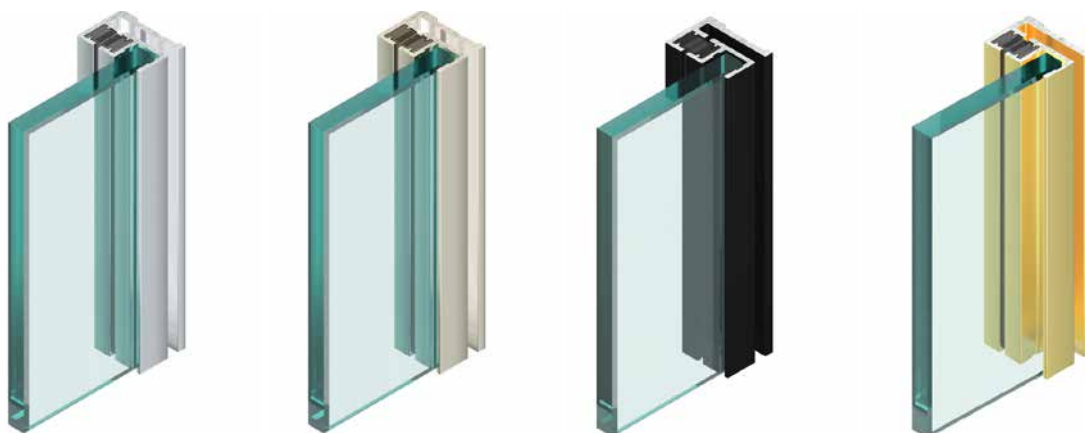

Produkto kodas Product code	Padengimas Finish
MAG-90-G-W-CH	chromuotas / chrome
MAG-90-G-W-SS	satinas / satin
MAG-90-G-W-B	juodas / black
MAG-90-G-W-G	auksas / gold
Savybės / Properties	
Ilgis / Length	2300 mm
Medžiaga / Material	aliuminis / aluminium

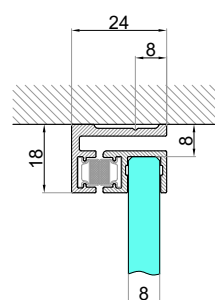
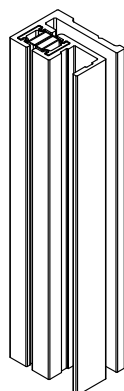

Aliuminio profilis su magnetine tarpine 90° stiklas-stiklas MAGNUM | MAG90-G-G

Aluminium magnetic seal 90° glass-glass MAGNUM

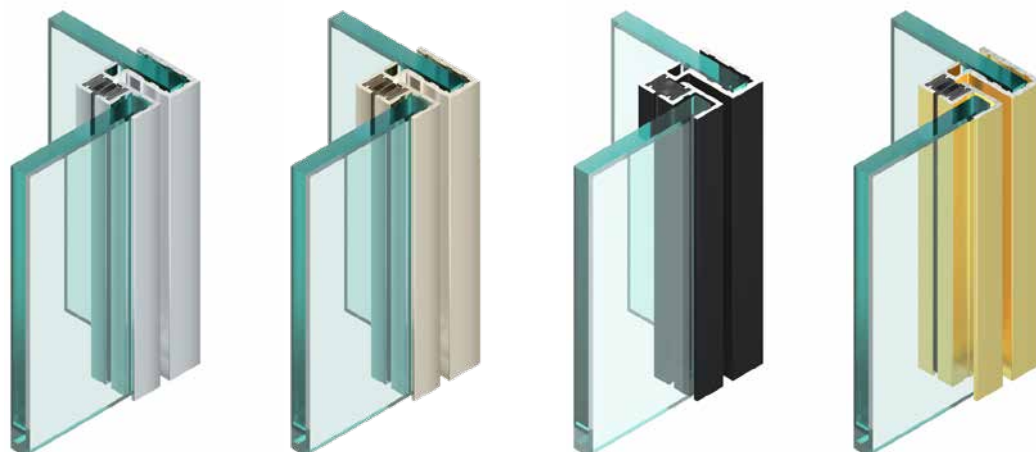

Produkto kodas Product code	Padengimas Finish
MAG-90-G-G-CH	chromuotas / chrome
MAG-90-G-G-SS	satinas / satin
MAG-90-G-G-B	juodas / black
MAG-90-G-G-G	auksas / gold
Savybės / Properties	
Ilgis / Length	2300 mm
Medžiaga / Material	aliuminis / aluminium

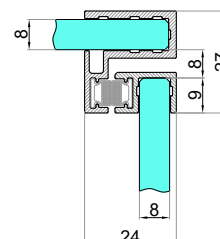
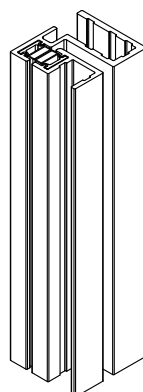

Aliuminio profilis su magnetine tarpine 180° siena-stiklas MAGNUM | MAG180-G-W

Aluminium magnetic seal 180° wall-glass MAGNUM

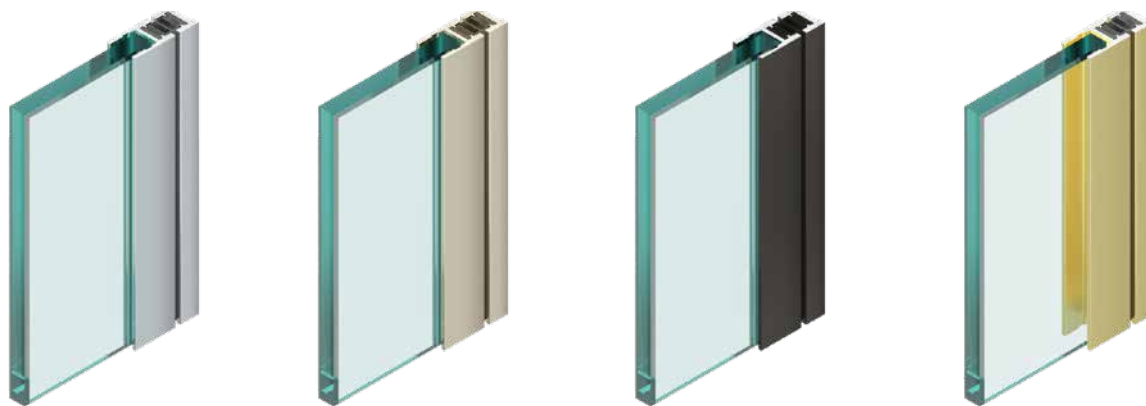

Produkto kodas Product code	Padengimas Finish
MAG-180-G-W-CH	chromuotas / chrome
MAG-180-G-W-SS	satinas / satin
MAG-180-G-W-B	juodas / black
MAG-180-G-W-G	auksas / gold
Savybės / Properties	
Ilgis / Length	2300 mm
Medžiaga / Material	aliuminis / aluminium

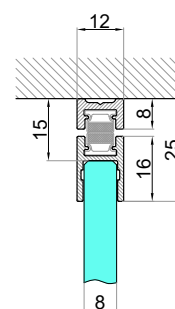
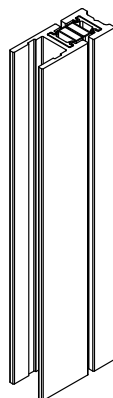

Aliuminio profilis su magnetine tarpine 180° stiklas-stiklas MAGNUM | MAG180-G-G

Aluminium magnetic seal 180° glass-glass MAGNUM

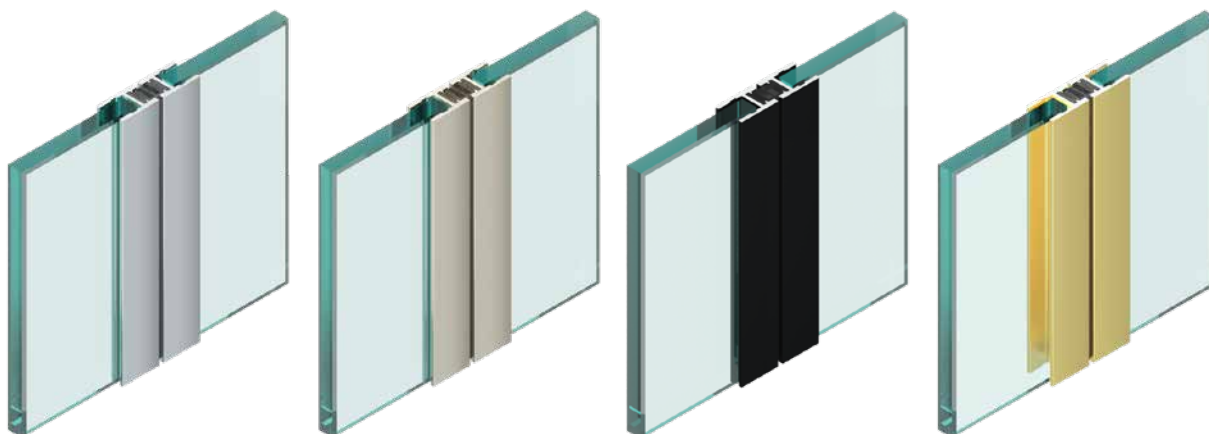

Produkto kodas Product code	Padengimas Finish
MAG-180-G-G-CH	chromuotas / chrome
MAG-180-G-G-SS	satinas / satin
MAG-180-G-G-B	juodas / black
MAG-180-G-G-G	auksas / gold
Savybės / Properties	
Ilgis / Length	2300 mm
Medžiaga / Material	aliuminis / aluminium

